



Server Series



STATIC LOADING CAPACITY

1500KG

Server Series



Standard

- Comply with ANSI/EIA, RS-310-D; IEC297-2; DIN41491: PART 1; DIN41491: PART 7; GB/T3047.2-92 standard, compatible with 19" international standard, metric system and ETSI standard

Features

- Reliable structure, static loading capacity: 1500KG
- Adjustable feet and castors are available
- Double mesh front door & back door
- Top and bottom cable entries
- Front door, back door and side panel can be easily removed
- Front & back door with spring lock
- Baying cabinets together easily
- Optional accessories

Materials

- SPCC cold rolling steel
- Mounting profile thickness : 2.0mm ; Others: 1.2mm



U numbered mounting rail



Wide angle door hinge



Spring Lock



Grounded terminal

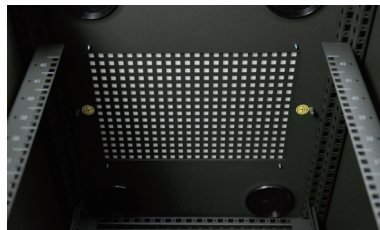

Top panel

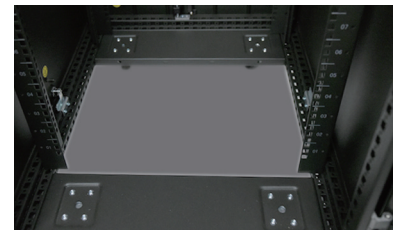

Open bottom for easy cable management

SPECIFICATIONS SUBJECT TO CHANGE WITHOUT NOTICE.

EIGHT LIMITED

No.18, 4/F., Thriving Industrial Centre, 26-38 Sha Tsui Road, Tsuen Wan, N.T., Hong Kong TEL : (852) 2413 2222 FAX : (852) 2411 3000 EMAIL : info@eightgroup.com

Server Series



Mesh Double Door



Side Panel



Back Door

Server Rack Cabinet

Model	Capacity (U)	Width (mm)	Depth (mm)	Height (mm)	Approx Weight (KG)
2268ST-E	22	600	800	1180	77
2260ST-E	22	600	1000	1180	86
2768ST-E	27	600	800	1405	91
2760ST-E	27	600	1000	1405	101
3268ST-E	32	600	800	1630	101
3260ST-E	32	600	1000	1630	112
3768ST-E	37	600	800	1855	110
3760ST-E	37	600	1000	1855	122
4268ST-E	42	600	800	2025	130
4260ST-E	42	600	1000	2025	132
4261ST-E	42	600	1100	2025	137
4262ST-E	42	600	1200	2025	144
4280ST-E	42	800	1000	2025	170
4281ST-E	42	800	1100	2025	173
4282ST-E	42	800	1200	2025	180
4760ST-E	47	600	1000	2280	148
4761ST-E	47	600	1100	2280	154
4780ST-E	47	800	1000	2280	188
4781ST-E	47	800	1100	2280	195

*Height Include Castor

SPECIFICATIONS SUBJECT TO CHANGE WITHOUT NOTICE.

EIGHT LIMITED

No.18, 4/F., Thriving Industrial Centre, 26-38 Sha Tsui Road, Tsuen Wan, N.T., Hong Kong TEL : (852) 2413 2222 FAX : (852) 2411 3000 EMAIL : info@eightgroup.com

Dimensions

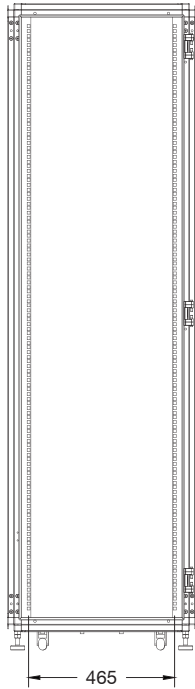

FRONT VIEW
(without door)

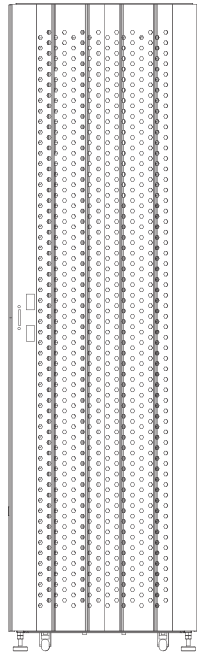

FRONT VIEW
(with door)

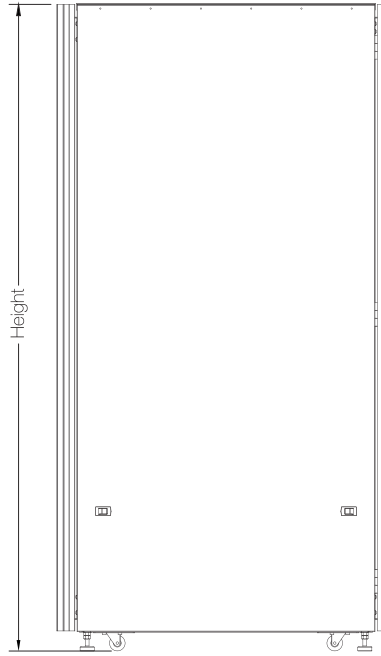

SIDE VIEW

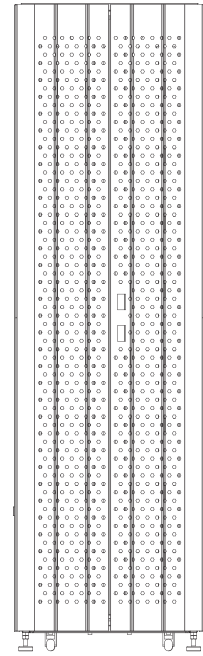

BACK VIEW

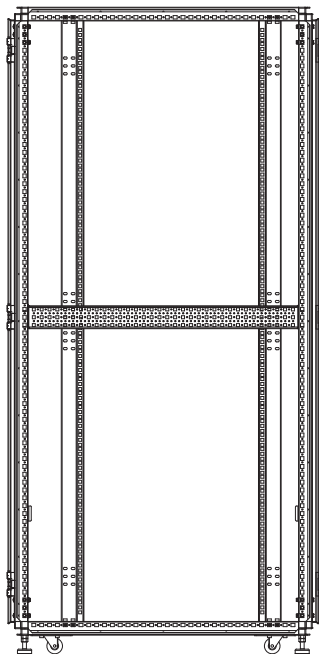

INNER STRUCTURE

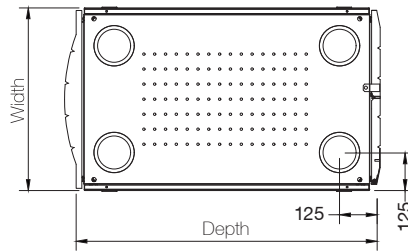

TOP VIEW
(with cover)

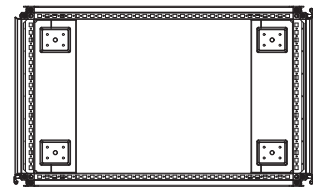

TOP VIEW
(without cover)

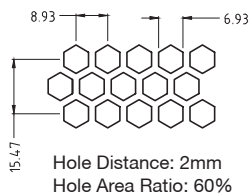

VENTED HOLES

SPECIFICATIONS SUBJECT TO CHANGE WITHOUT NOTICE.

Structure Diagrams

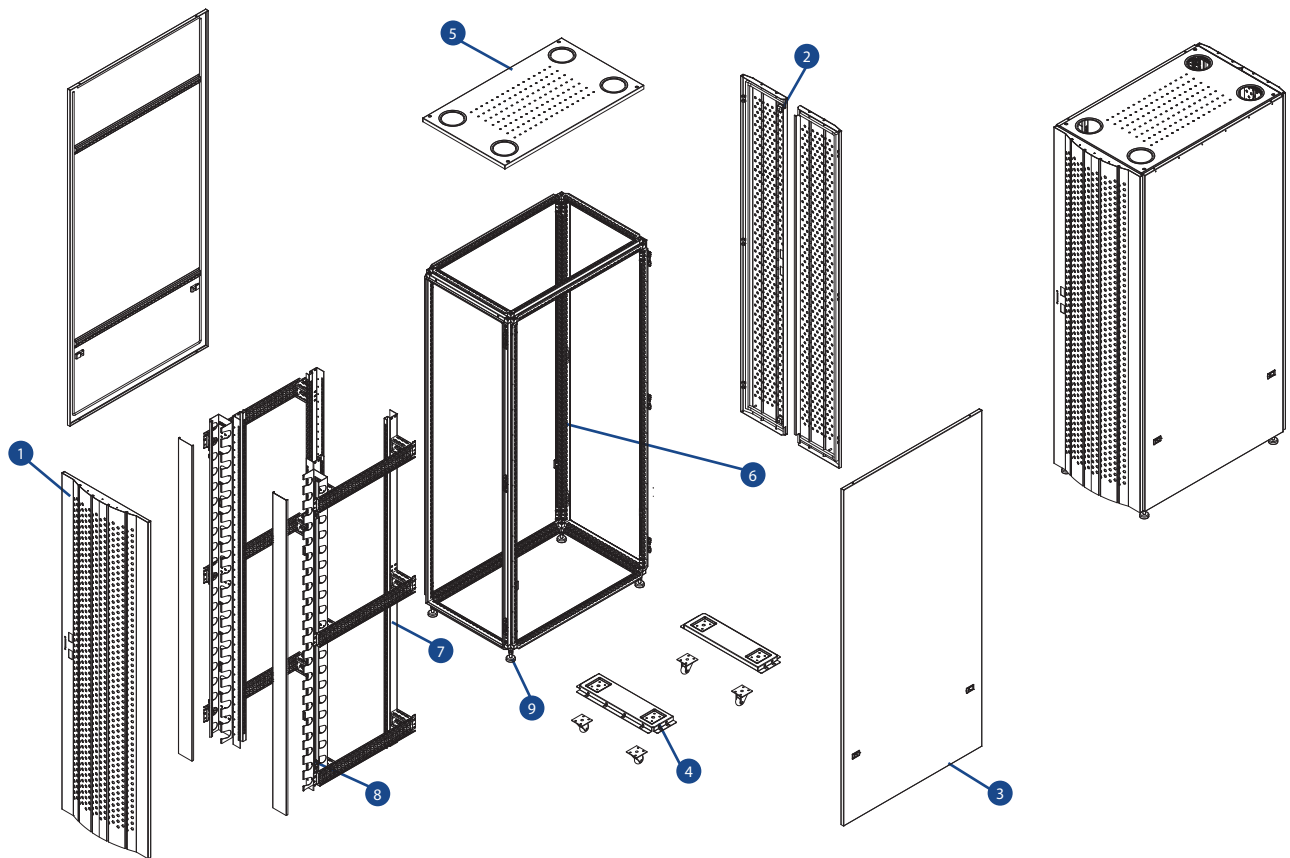

Server Rack Cabinet					
Number	Name of Parts	Quantity	Unit	Remark	
1	Front door	1	Piece	SPCC cold rolling steel	
2	Back Door	1	Piece	SPCC cold rolling steel	
3	Side Panel	2	Piece	SPCC cold rolling steel	
4	Bottom	2	Piece	SPCC cold rolling steel	
5	Top Cover	1	Piece	SPCC cold rolling steel	
6	Frame	1	Piece	SPCC cold rolling steel	
7	Mounting Profile	4	Piece	SPCC cold rolling steel	
8	Cable Manager	2	Piece	for 800 width cabinet only	
9	Adjustable Feet	4	Piece	---	
10	Castor	1	Set	---	
11	Lock	1	Piece	Zinc alloy	
12	Key	2	Piece	---	
13	M6 Screw	1	Set	---	

SPECIFICATIONS SUBJECT TO CHANGE WITHOUT NOTICE.

EIGHT LIMITED

No.18, 4/F., Thriving Industrial Centre, 26-38 Sha Tsui Road, Tsuen Wan, N.T., Hong Kong TEL : (852) 2413 2222 FAX : (852) 2411 3000 EMAIL : info@eightgroup.com